

**AUSTIN**

**Standard Features:**

- Advanced unidirectional suspension system
- Premium high-density, high-resiliency foam seat cushions
- Single-needle top-stitch
- In-arm control panel includes 2-amp USB charging port
- Stationary armless seats
- Lifetime warranty on frame and suspension
- Five-year warranty on mechanism
- Three-year warranty on motor
- Quick-ship delivery

**Options:**

- Premium high-density, high-resiliency foam seat cushions encased in down
- Back cushion options: **Hills** (channels), **Ridge** (saddle) or **Valley** (tufted)
- Contrasting stitch detail available in Black, Brown, Charcoal, Cream, Espresso, Grey, Lemon, Pink, Royal, Scarlet, Tangerine, or Teal thread color
- Option of motion in armless seats
- Lithium-ion battery pack available
- Battery pack has one-year warranty
- Wood legs available in Acorn, Espresso or Walnut finish

Please use actual leather, fabric, Crypton®, Sunbrella® and Ultrasuede® swatches when specifying furniture as the colors shown may vary due to the printing process.

**Note:** Microfiber fabrics such as SUEDELIFE and VEELIFE not suggested for this style. Please contact American Leather® Support Services for a complete list of recommended fabrics.

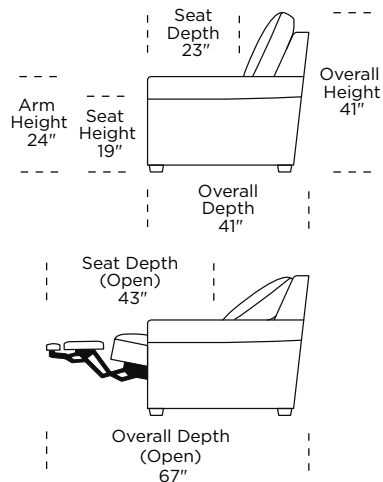

**Note:** Dotted line indicates seam on leather, Ultrasuede® and up the roll fabrics. Seams are eliminated with railroaded fabrics.

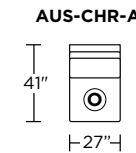
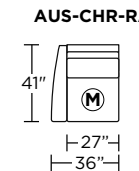
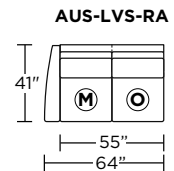
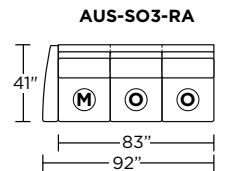
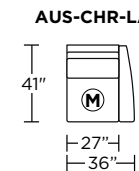
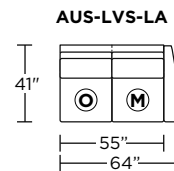
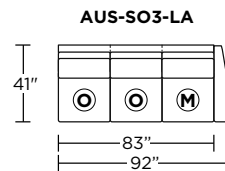
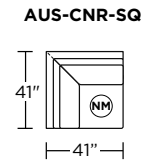
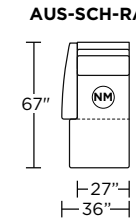
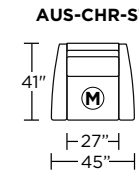
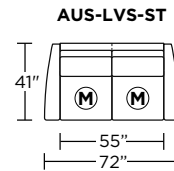
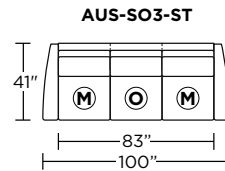
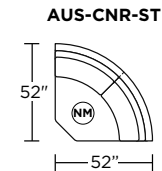
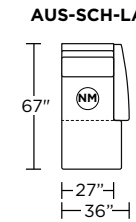
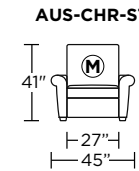
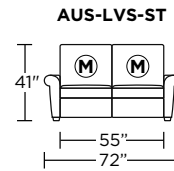
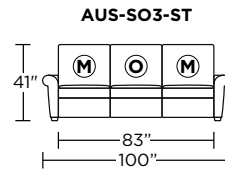

**MOTION LEGEND:**

- (M) = Motion only
- (O) = Optional motion or stationary
- (NM) = No motion available

**BACK CUSHION OPTIONS:**

- Hills (Channels)**
- Ridge (Saddle)**
- Valley (Tufted)**

V.11.12.19

Scale: 1/8 inch = 1 foot  
All dimensions are approximate and subject to change.  
Specify components from the sitting position.

**AUSTIN**

**Standard Features:**

- Featuring the patented Tiffany 24/7™ platform sleep system
- Room to stretch out with true 80 inches of bedroom-length sleeping surface
- Ultimate comfort on five inches of plush, high-density foam mattress
- Under-sofa dust covers keeps dust and dirt from ever touching the mattress
- Zero wall clearance
- Single-needle top-stitch
- Premium high-density, high-resiliency foam seat cushions
- Loose back and seat cushions
- Lifetime warranty on frame
- Ten-year warranty on mechanism
- Quick-ship delivery

**Mattress Options:**

- Premier with Crypton® ticking
- Gel
- Tempur-Pedic®

**Options:**

- High-density, high-resiliency foam seat cushions encased in down
- Back cushion options: **Hills** (channels), **Ridge** (saddle) or **Valley** (tufted)
- Contrasting stitch detail available in Black, Brown, Charcoal, Cream, Espresso, Grey, Lemon, Pink, Royal, Scarlet, Tangerine, or Teal thread color
- Wood legs available in Acorn, Espresso or Walnut finish

Please use actual leather, fabric, Crypton®, Sunbrella® and Ultrasuede® swatches when specifying furniture as the colors shown may vary due to the printing process.

**Note:** Microfiber fabrics such as SUEDELIFE and VEELIFE not suggested for this style. Please contact American Leather® Support Services for a complete list of recommended fabrics.

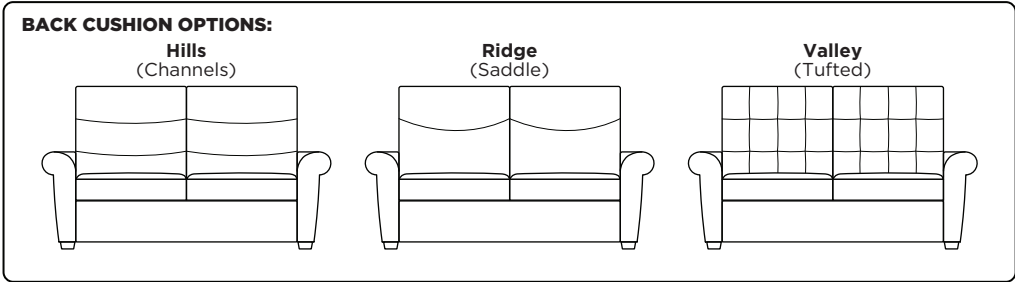
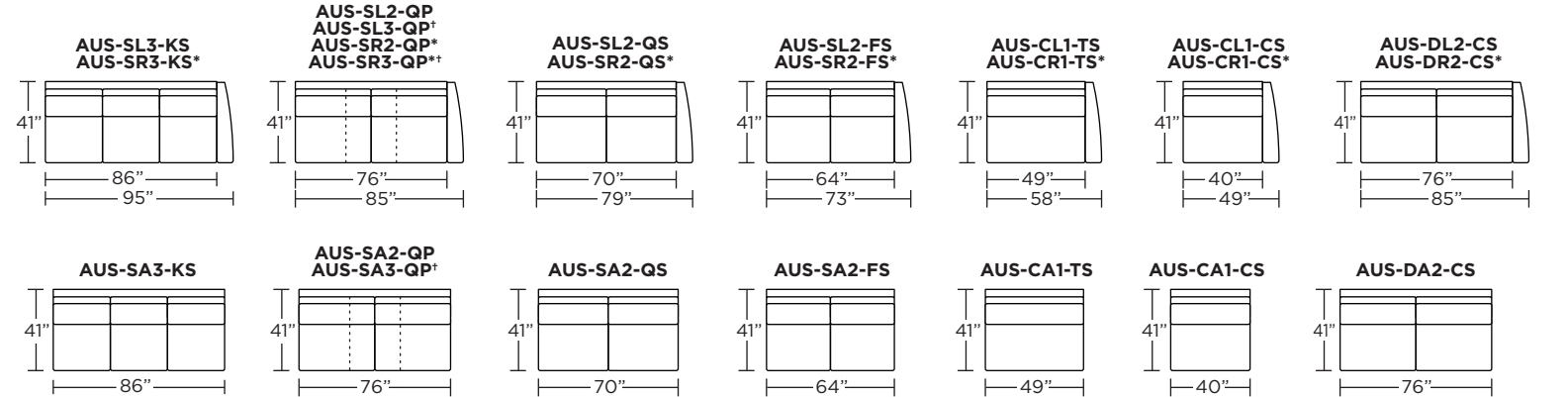
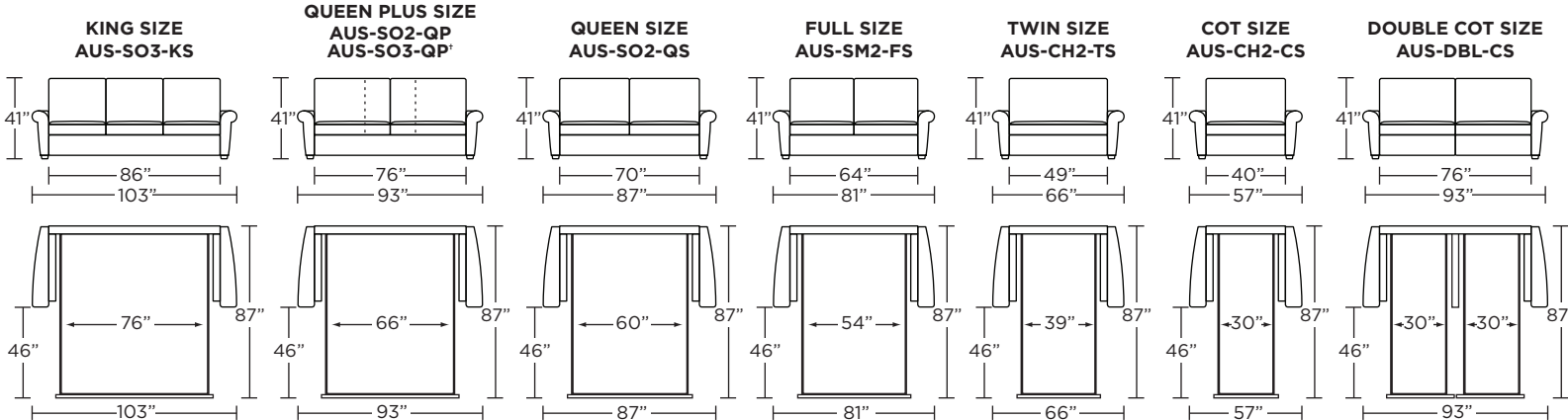
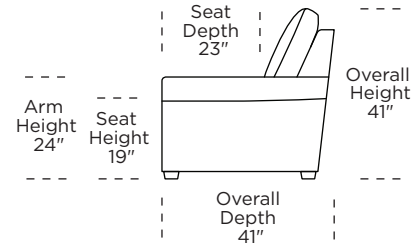

\* Picture shows left arm seated. Please specify left or right arm seated when ordering.  
 All orders are in seated position.  
 † Dotted lines for Queen Plus sizes indicates the number of seats.

Scale: 1/8 inch = 1 foot  
 All dimensions are approximate and subject to change.